







赣工机械设备科技（东莞）有限公司

网址：www.lusimin.com

电话：15920631511

## GGM1-M7

| 型号   |  |  |  |  |  |  |  |     |     |
|------|---|---|---|---|---|---|---|-----|-----|
|      | 功率/HP   | 工作气压/Mpa  | 耗气量m <sup>3</sup> /min  | 转速RPM/min   | 额定扭矩/N,m  | 最大扭矩/N,m  | 基本式   | 立式  | 卧式  |
| GGM1 | 1/8   | 0.3-0.7   | 0.18  | 1200  | 0.64  | 1.1   | 1.4   | 1.7 | 2.2 |
| GGM2 | 1/6   |   | 0.2   | 1100  | 0.84  | 1.57  | 2.1   | 2.3 | 2.8 |
| GGM3 | 1/4   |   | 0.26  | 900   | 1.7   | 2.3   | 2.7   | 3.1 | 3.6 |
| GGM4 | 1/3   |   | 0.3   | 800   | 3.5   | 3.92  | 3.3   | 3.7 | 4.2 |
| GGM5 | 1/2   |   | 0.395   | 750   | 4.7   | 6.5   | 5.0   | 5.5 | 6.5 |
| GGM6 | 3/4   |   | 0.54  | 650   | 7.6   | 11.5  | 5.8   | 6.5 | 7.8 |
| GGM7 | 1.5   |   | 0.99  | 360   | 28  | 45.8  | 23  |     | 29  |

## M5性能曲线

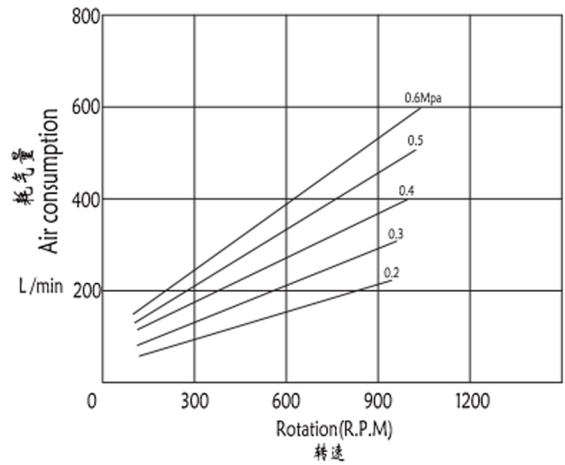
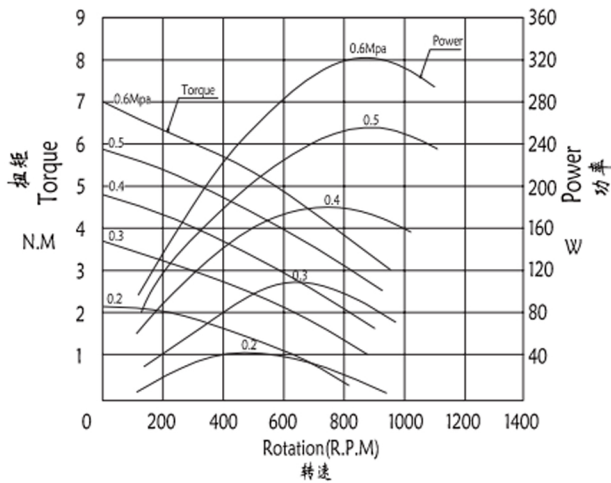

## GGM5-IEC

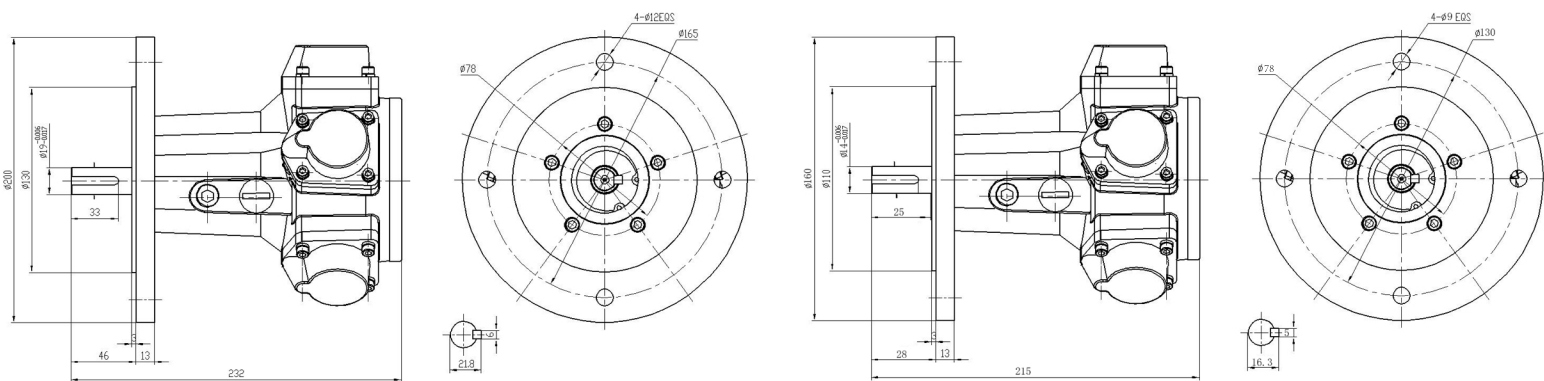

此款马达有两种安装尺寸